

# N.O.F. / Inc.



## 8' Heavy Duty Table - ADA Portable.

- Overall Dimensions: 95"L x 60 1/6"D x 30"H.
- Available as ADA accessible table in single or double sided accessibility.
- Wood style or aluminum style 2" x 10" planks.
- All MIG welded frame with zinc plated hardware.
- Frame available in 1 5/8" and 2 3/8" O.D. pipe with 1 5/16" O.D. brace.
- Zinc coated, galvanized, powder coated finish or galvanized frame.
- Available in Untreated Pine, Treated Pine, Redwood Stained Pine and Aluminum Planks.
- Some assembly required.

**Item #:** US 158H

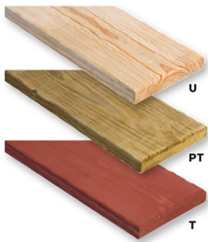

## Wood Planks

2" x 10" and 2" x 4" sizes  
Rounded Edges  
#1 Southern Yellow Pine

(U) Untreated  
(PT) Pressure Treated  
Environmentally Friendly ACQ  
Kiln Dried Before & After Treatment  
(T) Treated Stain  
Sealed in Redwood Stain With  
Wood Preservative

## Standard Powder Coat Colors



Model Number	Description
US 158HS-U8	8' ADA Table, 180 Lbs., One Sided, 1 5/8" O.D. Pipe, Untreated Pine, Portable.
US 158HS -PT8	8' ADA Table, 180 Lbs., One Sided, 1 5/8" O.D. Pipe, Treated Pine, Portable.
US 158HS -T8	8' ADA Table, 180 Lbs., One Sided, 1 5/8" O.D. Pipe, Redwood Stained Pine, Portable.
US 158HS -A8	8' ADA Table, 142 Lbs., One Sided, 1 5/8" O.D. Pipe, Aluminum, Portable.
US 158H-U8	8' ADA Table, 171 Lbs., Double Sided, 1 5/8" O.D. Pipe, Untreated Pine, Portable.
US 158H -PT8	8' ADA Table, 171 Lbs., Double Sided, 1 5/8" O.D. Pipe, Treated Pine, Portable.
US 158H -T8	8' ADA Table, 171 Lbs., Double Sided, 1 5/8" O.D. Pipe, Redwood Stained Pine, Portable.
US 158H -A8	8' ADA Table, 134 Lbs., Double Sided, 2 3/8" O.D. Pipe,, Aluminum, Portable.
US 238HS-U8	8' ADA Table, 203 Lbs., One Sided, 2 3/8" O.D. Pipe Untreated Pine, Portable.
US 238HS -PT8	8' ADA Table, 203 Lbs., One Sided, 2 3/8" O.D. Pipe Treated Pine, Portable.
US 238HS -T8	8' ADA Table, 203 Lbs., One Sided, 2 3/8" O.D. Pipe, Redwood Stained Pine, Portable.
US 238HS -A8	8' ADA Table, 166 Lbs., One Sided, 2 3/8" O.D. Pipe, Aluminum, Portable.
US 238H-U8	8' ADA Table, 194 Lbs., Double Sided, 2 3/8" O.D. Pipe, Untreated Pine, Portable.
US 238H -PT8	8' ADA Table, 194 Lbs., Double Sided, 2 3/8" O.D. Pipe, Treated Pine, Portable.
US 238H -T8	8' ADA Table, 194 Lbs., Double Sided, 2 3/8" O.D. Pipe, Redwood Stained Pine, Portable.
US 238H -A8	8' ADA Table, 157 Lbs., Double Sided, 2 3/8" O.D. Pipe, Aluminum, Portable.

**8' Single Sided ADA Table**

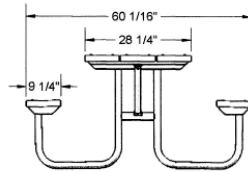
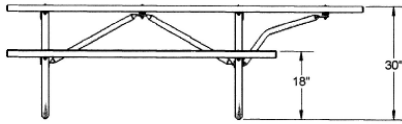
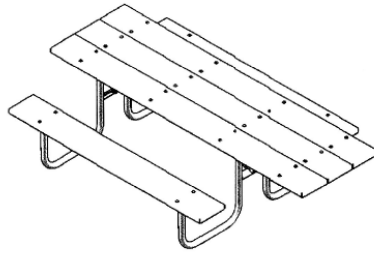
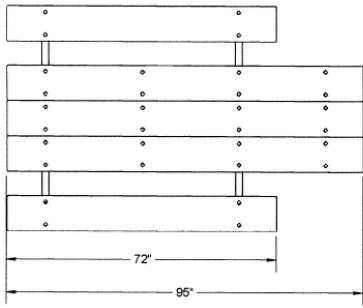

**8' Double Sided ADA Table**

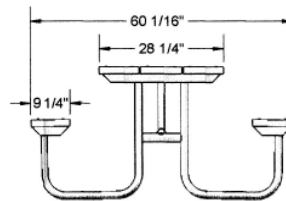
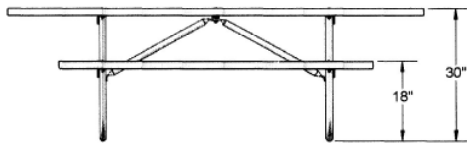
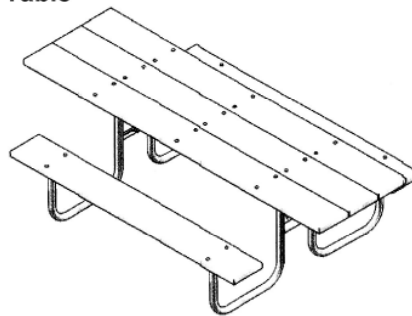
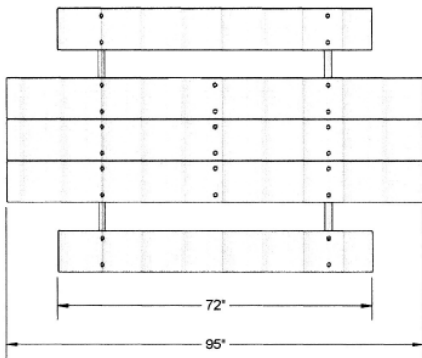

**NATIONAL OUTDOOR FURNITURE, INC.**  
 1210 W. Main Street #296 Riverhead, NY 11901  
 Toll-Free Phone: 1-888-663-4621  
 Phone: 631-369-9099 Fax: 631-207-8312  
 Email: [nofinc@optonline.net](mailto:nofinc@optonline.net)  
[www.nationaloutdoorfurniture.com](http://www.nationaloutdoorfurniture.com)

**NATIONAL OUTDOOR FURNITURE, INC.**  
 144 Murdock Road #325 Pomfret Center, CT 06259  
 Toll-Free Phone: 1-888-516-8873  
 Phone: 1-860-974-1551 Fax: 516-706-1901  
 Email: [nofinc@earthlink.net](mailto:nofinc@earthlink.net)  
[www.nationaloutdoorfurniture.com](http://www.nationaloutdoorfurniture.com)