



**Regal Web Style
Inground Mount**

**46" Square Web Table with (4) Attached Seats,
Rounded Corners - Inground Mount.**

- 303 lbs.
- Top and seats are made with polyethylene 3/4" #9 expanded metal inside a 2" x 2" x 1/8" angle iron frame.
- 2 3/8" O.D. zinc coated, powder coated galvanized frame.
- With umbrella hole.
- Some assembly required.

Item #: WC WSQ46IG

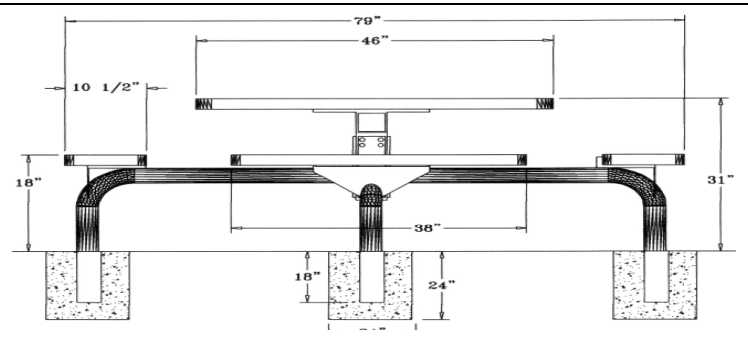

Textured Polyethylene Colors

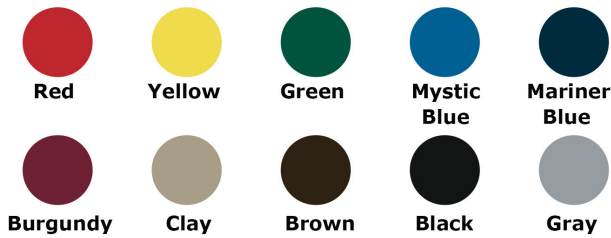

Powder Coat Gloss Colors



<p>NATIONAL OUTDOOR FURNITURE, INC. 1210 W. Main Street #296 Riverhead, NY 11901 Toll-Free Phone: 1-888-663-4621 Phone: 631-369-9099 Fax: 631-207-8312 Email: nofinc@optonline.net www.nationaloutdoorfurniture.com</p>	<p>NATIONAL OUTDOOR FURNITURE, INC. 144 Murdock Road #325 Pomfret Center, CT 06259 Toll-Free Phone: 1-888-516-8873 Phone: 1-860-974-1551 Fax: 516-706-1901 Email: nofinc@earthlink.net www.nationaloutdoorfurniture.com</p>
---	---