

N.O.F. / Inc.



4' Brooklyn Recycled Plastic Bench -Portable.

- Also available in 6' length as shown.
- 90 lbs.
- Dim: 48"W x 21"D x 28"Ht.
- Made with two 2" x 6" recycled plastic slats and two black recycled plastic bases.
- All holes are predrilled and countersunk for plastic lumber.
- Includes a UV protectant.
- Maintenance free.
- Available in green, cedar, brown and gray with black base.
- Some assembly required.

Item# JP PB4BROOK

Model Number	Weight	Dimensions
JP PB4BROOK	90 Lbs.	48"W x 21"D x 28" Ht.- 2 Bases
JP PB6BROOK	125 Lbs.	72"W x 21"D x 28" Ht.- 3 Bases

Resinwood Slat Colors



Cedar



Green



Gray



Brown

NATIONAL OUTDOOR FURNITURE, INC.

1210 W. Main Street #296 Riverhead, NY 11901
 Toll-Free Phone: 1-888-663-4621
 Phone: 631-369-9099 Fax: 631-207-8312
 Email: nofinc@optonline.net
www.nationaloutdoorfurniture.com

NATIONAL OUTDOOR FURNITURE, INC.

144 Murdock Road #325 Pomfret Center, CT 06259
 Toll-Free Phone: 1-888-516-8873
 Phone: 1-860-974-9996 Fax: 516-706-1901
 Email: nofinc@earthlink.net
www.nationaloutdoorfurniture.com

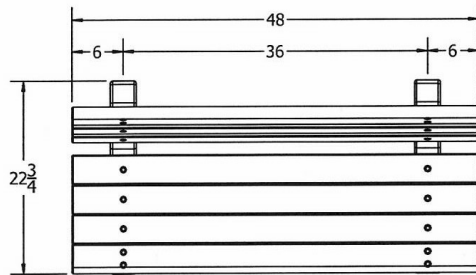

TOP VIEW

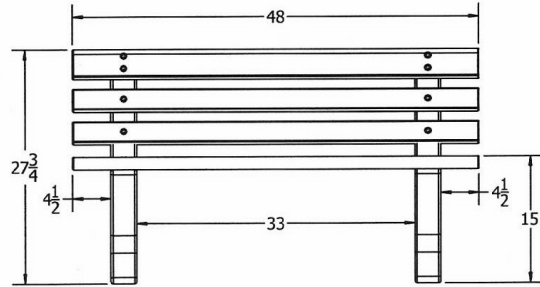

FRONT VIEW



3D ISOMETRIC VIEW

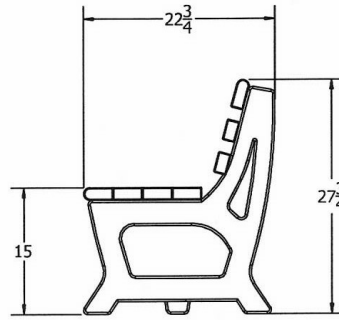

SIDE VIEW

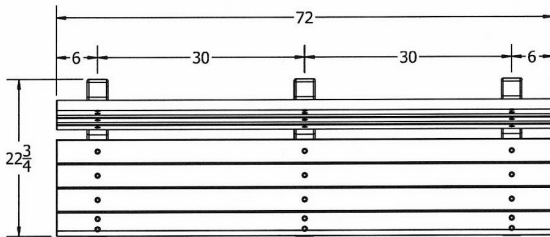

TOP VIEW

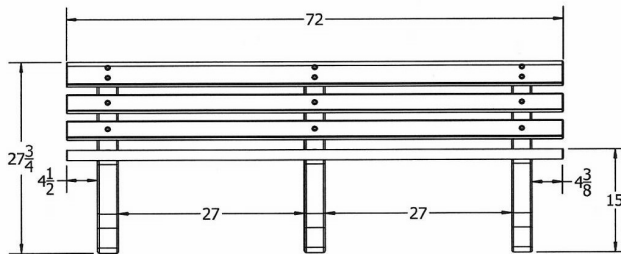

FRONT VIEW

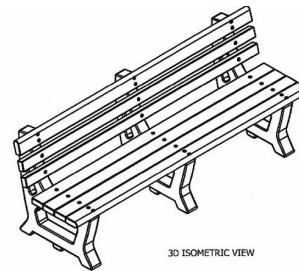

3D ISOMETRIC VIEW

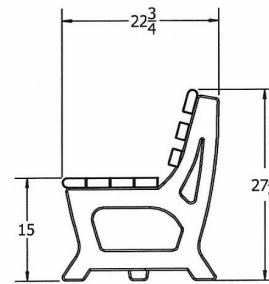

SIDE VIEW

NATIONAL OUTDOOR FURNITURE, INC.

1210 W. Main Street #296 Riverhead, NY 11901
 Toll-Free Phone: 1-888-663-4621
 Phone: 631-369-9099 Fax: 631-207-8312
 Email: nofinc@optonline.net
www.nationaloutdoorfurniture.com

NATIONAL OUTDOOR FURNITURE, INC.

144 Murdock Road #325 Pomfret Center, CT 06259
 Toll-Free Phone: 1-888-516-8873
 Phone: 1-860-974-9996 Fax: 516-706-1901
 Email: nofinc@earthlink.net
www.nationaloutdoorfurniture.com