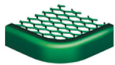
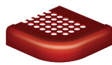



Table Styles



Diamond



Perforated

Thermoplastic Colors



Ultra Blue



Burgundy



Green



Beige



Blue



Red



Brown



Black

Standard Powder Coat Colors



BURGUNDY



RED



ORANGE



YELLOW



SPRING GREEN



GREEN



NEW ROYAL PURPLE



ULTRA BLUE



BLUE



SKY BLUE



BEIGE



BROWN



BLACK

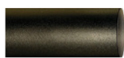

MATTE BLACK



DARK GREY



NEW CHAMPAGNE



WHITE

46" Square Capri Table with (4) Attached Seats and Backs - Portable.

- 238 and 292 Lbs.
- Overall Dimensions: 97 1/2"L x 97 1/2"W x 35 9/16"H.
- Available in diamond and perforated seats and tops.
- All MIG welded frame
- 1 5/8" O.D. all bolt together walk through frame.
- Thermoplastic coated seats and tops with powder coated frame.
- All stainless steel hardware.
- Also available with octagonal top.
- Some assembly required.

Item #: US 358

Model Number	Description
US 358-VC	46" Square Table, Diamond Style, Portable.
US 358-OVC	46" Octagon Table, Diamond Style, Portable
US 358-PC	46" Square Table, Perforated Style, Portable.
US 358-OPC	46" Octagon Table, Perforated Style, Portable



National Outdoor Furniture
1210 W. Main Street #296
Riverhead, N.Y. 11901

PHONE (888) 663-4621
E-MAIL nofinc1@gmail.com

www.nationaloutdoorfurniture.com

46" Square Capri Table with (4) Attached Seats - Portable

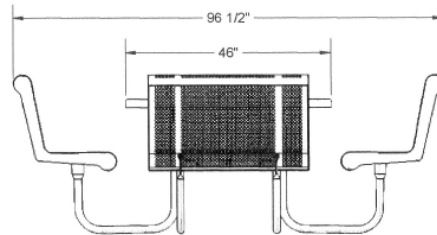
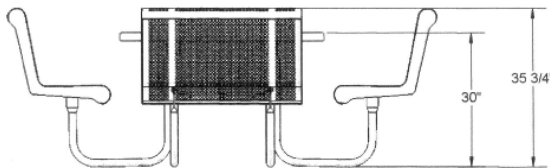
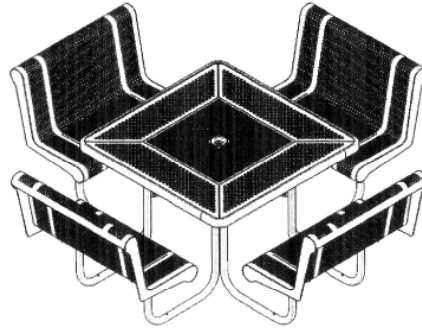
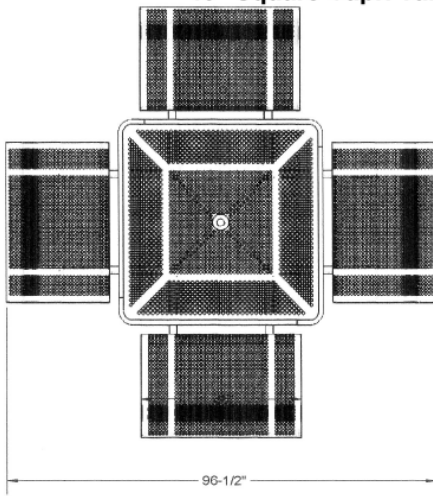

46" Octagon Capri Table with (4) Attached Seats & Backs - Portable

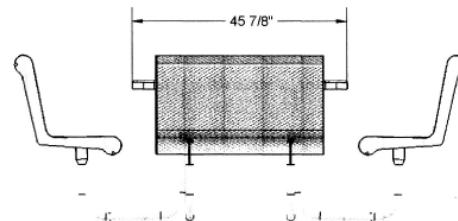
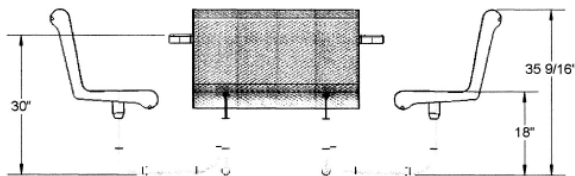
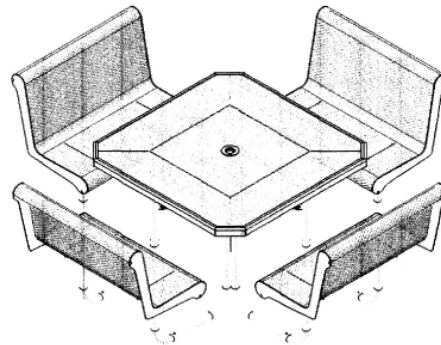
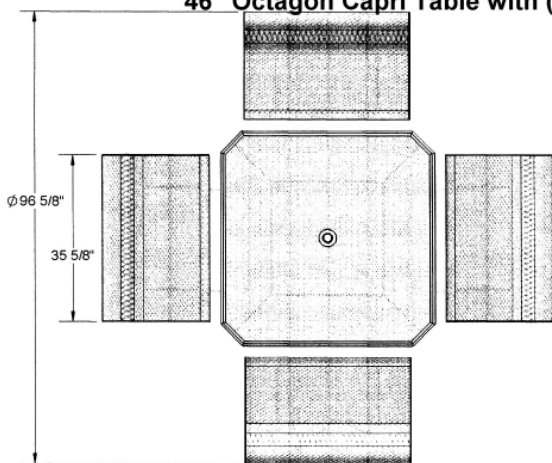

National Outdoor Furniture
1210 W. Main Street #296
Riverhead, N.Y. 11901

PHONE (888) 663-4621
E-MAIL nofinc1@gmail.com

www.nationaloutdoorfurniture.com